

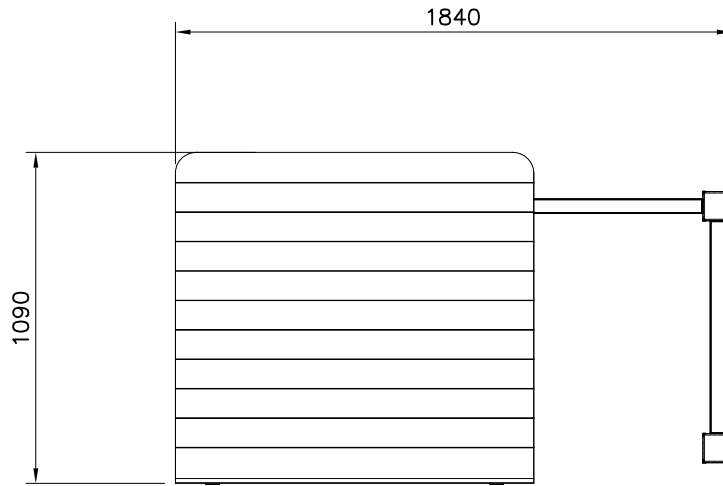

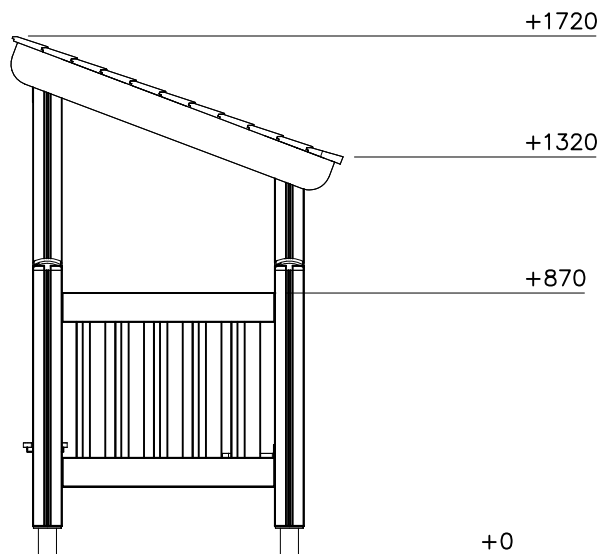

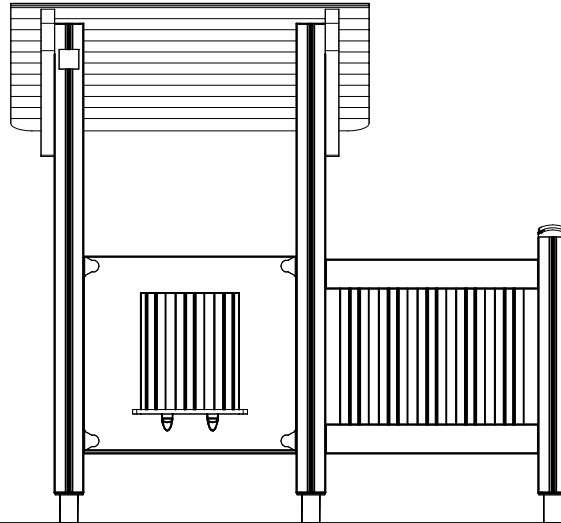

- EN/AS Impact Area 0.2 m<sup>2</sup>
- Falling Space 0.2 m<sup>2</sup>  
Max Falling Height 0000 mm



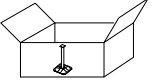
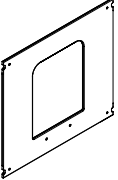
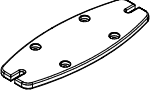
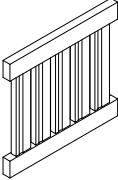
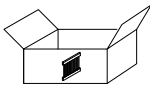
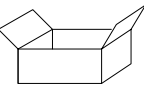
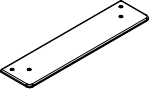
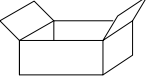
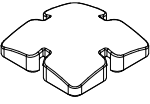
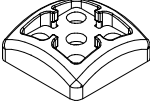
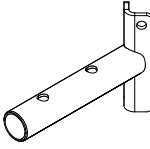
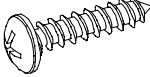
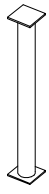
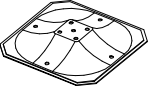
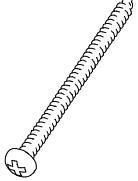

DATE: 5.12.2017

701401-602	PCS	702286	PCS	703139	PCS	706441-602	PCS	706499-602	PCS	706531	PCS
	2		1		1		2		2		6
L 1250		65x65				93x93x1550		93x93x860			
706727-703	PCS	706744	PCS	706746-611	PCS	706748	PCS	706753	PCS	706783	PCS
	1		1		4		4		1		1
10x702x640		15x145x380		45x640x701						15x170x700	
706885	PCS	905138	PCS	905196	PCS	907783-216	PCS	909506	PCS	909511	PCS
	1		2		2		2		4		6
		GRAY		GRAY				Ø3.5x13		90x90x650	
909519	PCS	980131	PCS		PCS		PCS		PCS		PCS
	6		8								
50x380x380		Ø6x60									
	PCS		PCS		PCS		PCS		PCS		PCS
	PCS		PCS		PCS		PCS		PCS		PCS
	PCS		PCS		PCS		PCS		PCS		PCS