

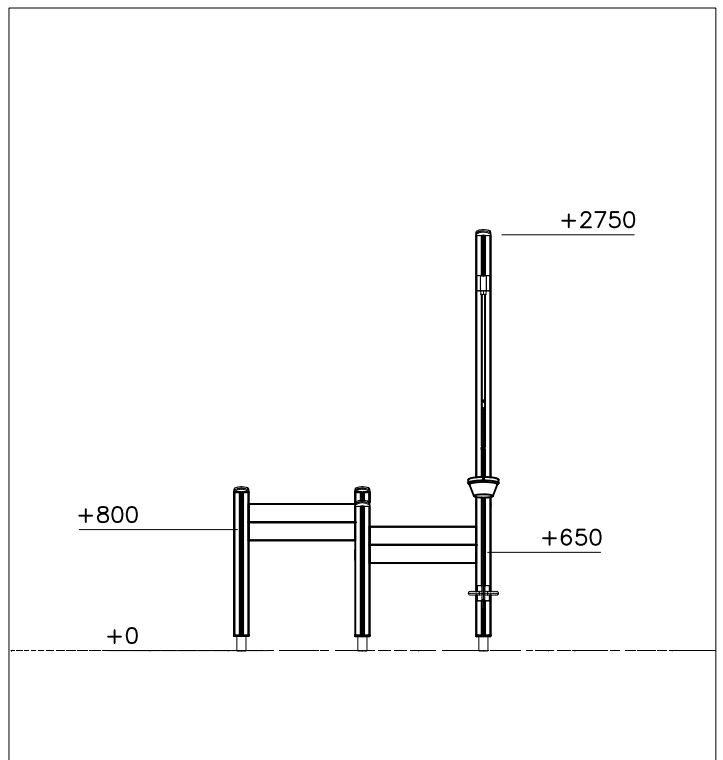

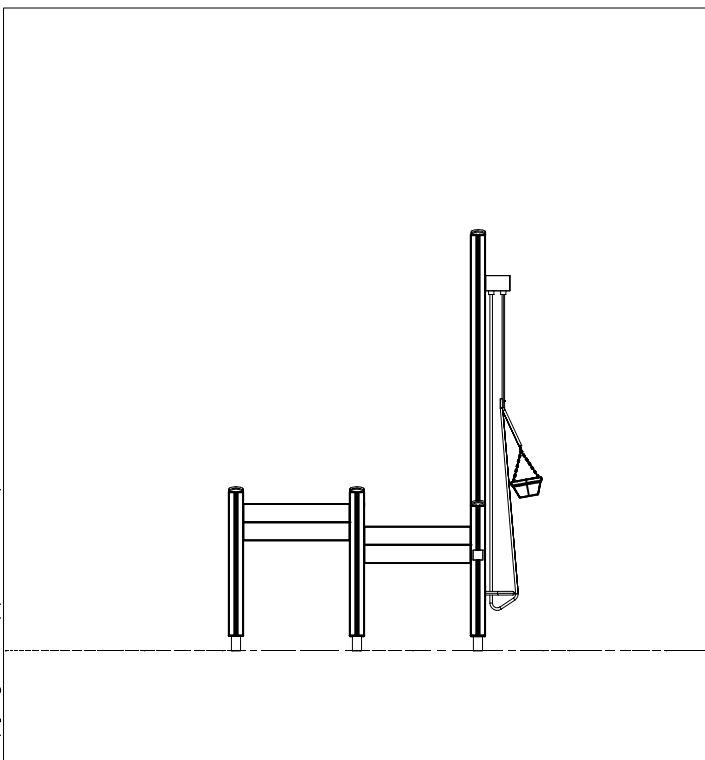

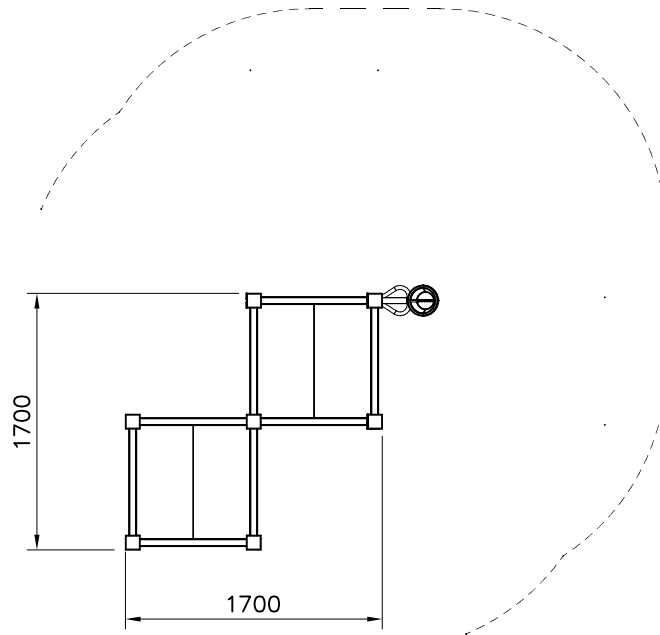
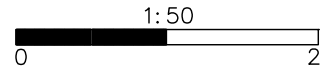

EN/AS Impact Area 17.5 m²

Falling Space 19.9 m²

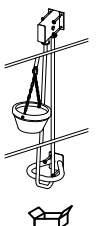
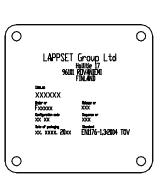
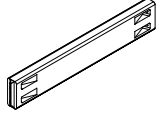
Max Falling Height 800 mm

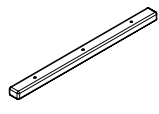
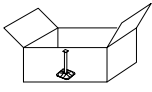

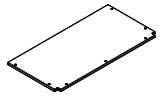
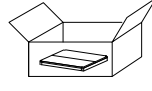
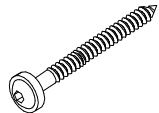
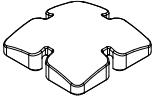
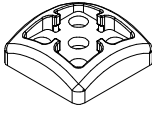
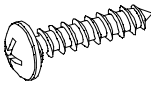
DATE: 16.4.2018

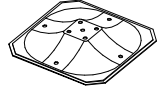
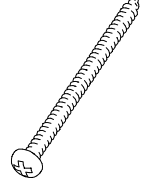
701959  PCS 1	702286  PCS 1 65x65	706439-602  PCS 16 L 704	706499-602  PCS 2 93x93x860	706508  PCS 8 32x45x650	706531  PCS 7
706810-602  PCS 1 93x93x2650	706894-602  PCS 4 L 950	707327-704  PCS 4 15x375x750	707515  PCS 2	903093  PCS 64 Ø8x90	905138  PCS 7 GRAY
905196  PCS 7 GRAY	909506  PCS 4 Ø3.5x13	909511  PCS 7 90x90x650	909519  PCS 7 50x380x380	980131  PCS 28 Ø6x60	